

XL-MaxSonar® - EZ™ Series

High Performance Sonar Range Finder

MB1200, MB1210, MB1220, MB1230, MB1240, MB1260, MB1261
MB1300, MB1310, MB1320, MB1330, MB1340, MB1360, MB1361



The XL-MaxSonar-EZ series has high power output along with real-time auto calibration for changing conditions (temperature, voltage and acoustic or electrical noise) that ensure you receive the most reliable (in air) ranging data for every reading taken. The XL-MaxSonar-EZ/AE sensors have a low power requirement of 3.3V – 5.5V and operation provides very short to long-range detection and ranging, in a tiny and compact form factor. The MB1200 and MB1300 sensor series detects objects from 0-cm¹ to 765-cm (25.1 feet) or 1068cm (35 feet) (select models) and provide sonar range information from 20-cm² out to 765-cm or 1068-cm (select models) with 1-cm resolution. Objects from 0-cm¹ to 20-cm^{2,3} typically range as 20-cm^{2,3}. The interface output formats included are pulse width output (MB1200 series), real-time analog voltage envelope (MB1300 series), analog voltage output, and serial digital output.

¹Objects from 0-mm to 1-mm may not be detected. ²For the MB1200/MB1300, MB1210/1310 and MB1260/MB1360, this distance is 25-cm. ³Please see Close Range Operation

Features	Benefits	Applications and Uses
<ul style="list-style-type: none"> • High acoustic power output • Real-time auto calibration and noise rejection for every ranging cycle • Calibrated beam angle • Continuously variable gain • Object detection as close as 1-mm from the sensor • 3.3V to 5V supply with very low average current draw⁶ • Readings can occur up to every 100mS, (10-Hz rate) • Free run operation can continually measure and output range information • Triggered operation provides the range reading as desired • Pulse Width (MB1200 series) • Real-time analog envelope (MB1300 series) • All interfaces are active simultaneously • Sensor operates at 42KHz • Serial, 0 to Vcc, 9600Baud, 81N • Analog, (Vcc/1024) / cm⁴ • Analog, (Vcc/1024 / 2cm⁵ 	<ul style="list-style-type: none"> • Acoustic and electrical noise resistance • Reliable and stable range data • Low cost • Quality controlled beam characteristics • Very low power ranger, excellent for multiple sensor or battery based systems • Ranging can be triggered externally or internally • Sensor reports the range reading directly, frees up user processor • Fast measurement cycle • User can choose any of the sensor outputs • Easy mounting • No power up calibration required • Perfect for objects may be directly in front of the sensor during power up 	<ul style="list-style-type: none"> • Bin level measurement • Proximity zone detection • People detection • Robot ranging sensor • Autonomous navigation • Environments with acoustic and electrical noise • Multi-sensor arrays • Distance measuring • Long range object detection • Users who prefer to process the analog voltage envelope (MB1300 series) • -40°C to +65°C operation (+85°C limited operation) (40°C to 0°C recommended operation in environments that are non-frosting, non-condensation, and indoor only) <p>Notes:</p> <p>⁴ MB1200 through MB1240 and MB1300 through MB1340</p> <p>⁵ MB1260, MB1261, MB1300, MB1361</p> <p>⁶ See page 2, Pin 6 Vcc Operation</p>

Close Range Operation

Applications requiring 100% reading-to-reading reliability should not use MaxSonar sensors at a distance closer than 20cm. Although most users find MaxSonar sensors to work reliably from 0 to 20cm (25cm select models) for detecting objects in many applications, MaxBotix® Inc. does not guarantee operational reliability for objects closer than the minimum reported distance. Because of ultrasonic physics, these sensors are unable to achieve 100% reliability at close distances.

Warning: Personal Safety Applications

We do not recommend or endorse this product be used as a component in any personal safety applications. This product is not designed, intended or authorized for such use. These sensors and controls do not include the self-checking redundant circuitry needed for such use. Such unauthorized use may create a failure of the MaxBotix® Inc. product which may result in personal injury or death. MaxBotix® Inc. will not be held liable for unauthorized use of this component.

About Ultrasonic Sensors

Our ultrasonic sensors are in air, non-contact object detection and ranging sensors that detect objects within an area. These sensors are not affected by the color or other visual characteristics of the detected object. Ultrasonic sensors use high frequency sound to detect and localize objects in a variety of environments. Ultrasonic sensors measure the time of flight for sound that has been transmitted to and reflected back from nearby objects. Based upon the time of flight, the sensor then outputs a range reading.

XL-MaxSonar[®]-EZ™ Pin Out

Pin 1-BW-Leave open (or high) for serial output on the Pin 5 output. When Pin 1 is held low the Pin 5 output sends a pulse (instead of serial data), suitable for low noise chaining.

Pin 2-PW- For the MB1200 (EZ) sensor series, this pin outputs a pulse width representation of range. To calculate distance, use the scale factor of 58uS per cm.

For the MB1300 (AE) sensor series, this pin outputs the analog voltage envelope of the acoustic wave form. The output allows the user to process the raw waveform of the sensor.

Pin 3-AN- For the 7.6 meter sensors (all sensors except for MB1260, MB1261, MB1360, and MB1361), this pin outputs analog voltage with a scaling factor of $(V_{cc}/1024)$ per cm. A supply of 5V yields $\sim 4.9\text{mV}/\text{cm}$., and 3.3V yields $\sim 3.2\text{mV}/\text{cm}$. Hardware limits the maximum reported range on this output to $\sim 700\text{cm}$ at 5V and $\sim 600\text{cm}$ at 3.3V. The output is buffered and corresponds to the most recent range data.

For the 10 meter sensors (MB1260, MB1261, MB1360, MB1361), this pin outputs analog voltage with a scaling factor of $(V_{cc}/1024)$ per 2 cm. A supply of 5V yields $\sim 4.9\text{mV}/2\text{cm}$., and 3.3V yields $\sim 3.2\text{mV}/2\text{cm}$. The output is buffered and corresponds to the most recent range data.

Pin 4-RX- This pin is internally pulled high. The XL-MaxSonar-EZ sensors will continually measure range and output if the pin is left unconnected or held high. If held low the will stop ranging. Bring high 20uS or more for range reading.

Pin 5-TX- When Pin 1 is open or held high, the Pin 5 output delivers asynchronous serial with an RS232 format, except voltages are 0-Vcc. The output is an ASCII capital "R", followed by three ASCII character digits representing the range in centimeters up to a maximum of 765, followed by a carriage return (ASCII 13). The baud rate is 9600, 8 bits, no parity, with one stop bit. Although the voltage of 0-Vcc is outside the RS232 standard, most RS232 devices have sufficient margin to read 0-Vcc serial data. If standard voltage level RS232 is desired, invert, and connect an RS232 converter such as a MAX232.

When Pin 1 is held low, the Pin 5 output sends a single pulse, suitable for low noise chaining (no serial data).

Pin 6-+5V- Vcc – Operates on 3.3V - 5V. The average (and peak) current draw for 3.3V operation is 2.1mA (50mA peak) and at 5V operation is 3.4mA (100mA peak) respectively. Peak current is used during sonar pulse transmit.

Pin 7-GND- Return for the DC power supply. GND (& V+) must be ripple and noise free for best operation.

Product Release Notes

For all MB1260/MB1360 sensors sold after Feb 20, 2013, the minimum reported distance is 25cm.

For all MB1200/MB1300 sensors sold after Oct 01, 2013, the minimum reported distance is 25cm.

For all MB1210/MB1310 sensors sold after Oct 01, 2013, the minimum reported distance is 25cm.

Sensor Minimum Distance

The sensor minimum reported distance is 20cm¹ (7.87 inches). However, the XL-MaxSonar-EZ will range and report targets to the front sensor face. Large targets closer than 20cm¹ will typically range as 20cm¹.

Sensor Operation from 6-inches to 20-inches

Because of acoustic phase effects in the near field, objects between 20cm and 50cm may experience acoustic phase cancellation of the returning waveform resulting in inaccuracies. These effects become less prevalent as the target distance increases, and has not been observed past 50cm. For this reason, industrial users that require the highest sensor accuracy are encouraged to mount the XL-MaxSonar-EZ from objects that are farther than 50cm.

Range “0” Location

The XL-MaxSonar-EZ reports the range to distant targets starting from the front of the sensor as shown in the diagram below.

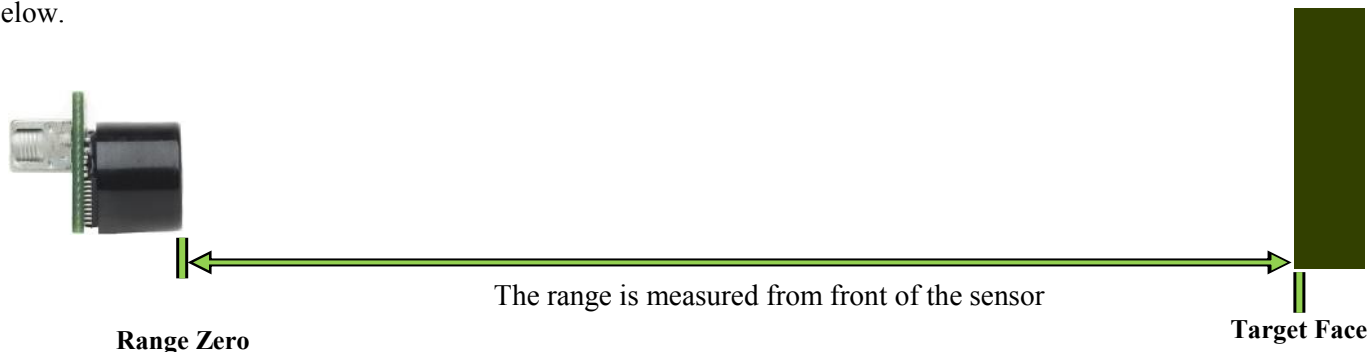

In general, the XL-MaxSonar-EZ will report the range to the leading edge of the closest detectable object. Target detection has been characterized in the sensor beam patterns.

Mechanical Dimensions

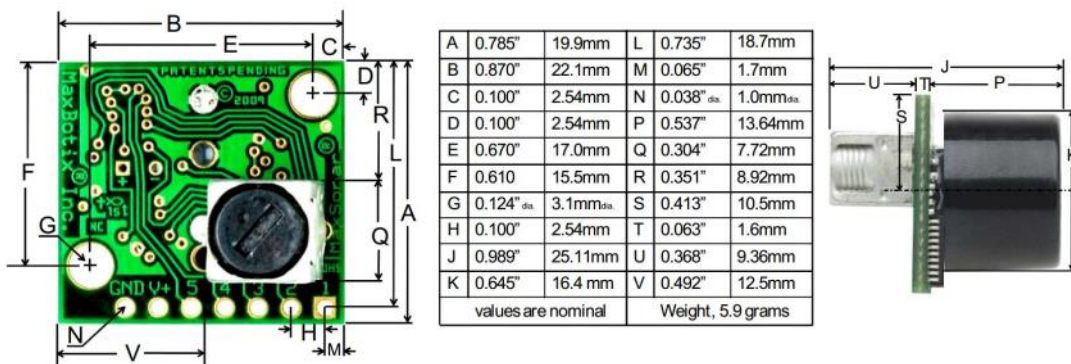

XL-MaxSonar-EZ/AE Real-Time Auto Calibration

Each time before the XL-MaxSonar sensor takes a range reading it calibrates itself. The sensor then uses this data to range to objects. If the temperature, humidity, or applied voltage changes during operation, the sensor will continue to function normally. The sensor does not apply compensation for the speed of sound change versus temperature to any range readings.

XL-MaxSonar®-EZ™ Temperature Compensation

The speed of sound in air increases about 0.6 meters per second, per degree centigrade. The XL-MaxSonar-EZ sensors are not equipped with an internal temperature compensation. If temperature compensation is desired, contact MaxBotix and request the temperature compensation formula PDF. This will allow users to compensation for speed of sound changes.

Real-time Noise Rejection

While the XL-MaxSonar® is designed to operate in the presence of noise, best operation is obtained when noise strength is low and desired signal strength is high. Hence, the user is encouraged to mount the sensor in such a way that minimizes outside acoustic noise pickup. In addition, keep the DC power to the sensor free of noise. This will let the sensor deal with noise issues outside of the users direct control (in general, the sensor will still function well even if these things are ignored). Users are encouraged to test the sensor in their application to verify usability.

For every ranging cycle, individual filtering for that specific cycle is applied. In general, noise from regularly occurring periodic noise sources such as motors, fans, vibration, etc., will not falsely be detected as an object. This holds true even if the periodic noise increases or decreases (such as might occur in engine throttling or an increase/decrease of wind movement over the sensor). Even so, it is possible for sharp non-periodic noise sources to cause false target detection. In addition, *(because of dynamic range and signal to noise physics,) as the noise level increases, at first only small targets might be missed, but if noise increases to very high levels, it is likely that even large targets will be missed.

*In high noise environments, if needed, use 5V power to keep acoustic signal power high. In addition, a high acoustic noise environment may use some of the dynamic range of the sensor, so consider a part with less gain such as the MB1220/MB1320 MB1230/MB1330 or MB1240/MB1340. For applications with large targets, consider a part with ultra clutter rejection like the MB7369.

Typical Performance to Target

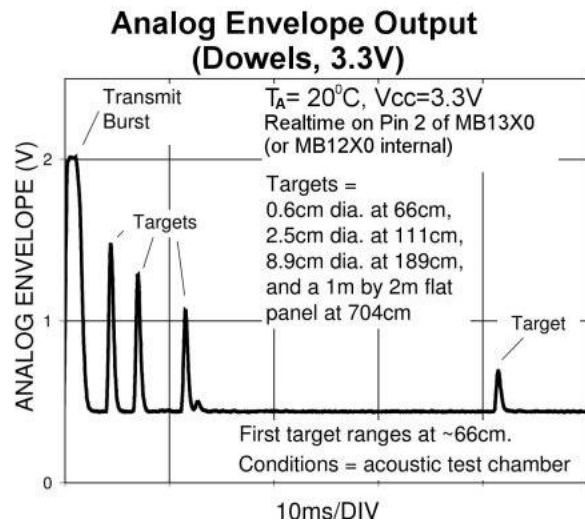
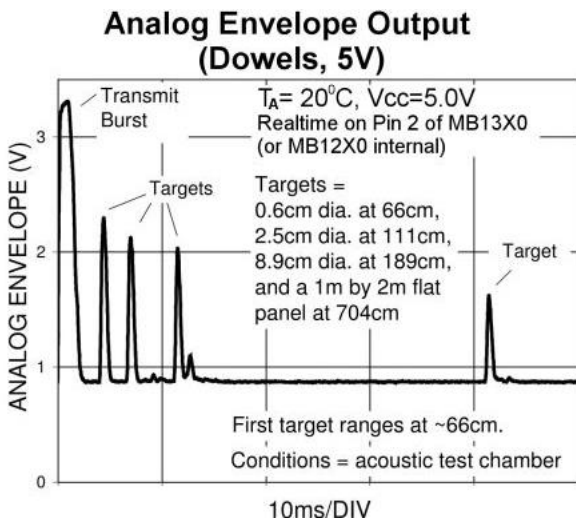

Typical Performance in clutter

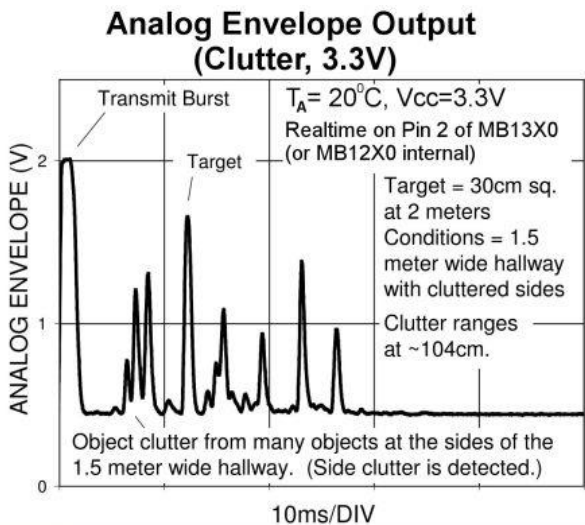
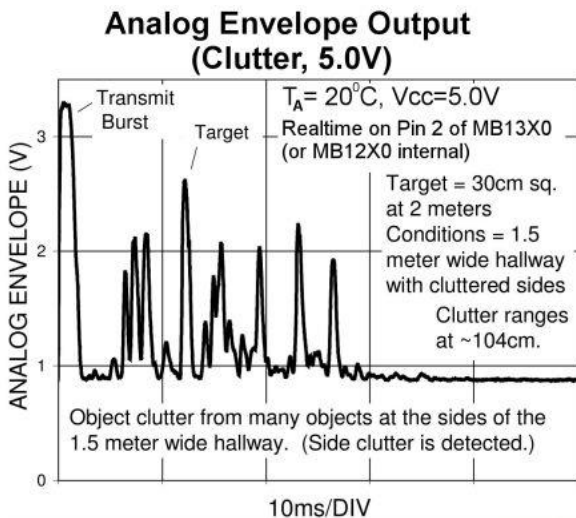

Sensor Timing Diagrams

Power Up Timing

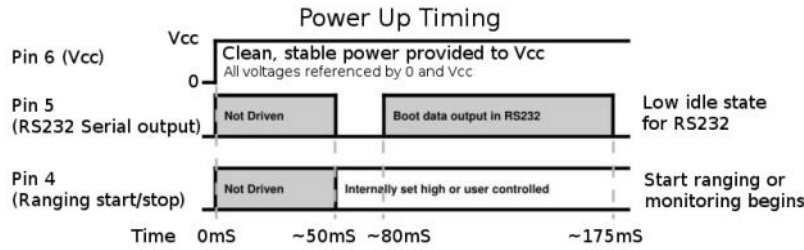

Sensor Free-Run Timing

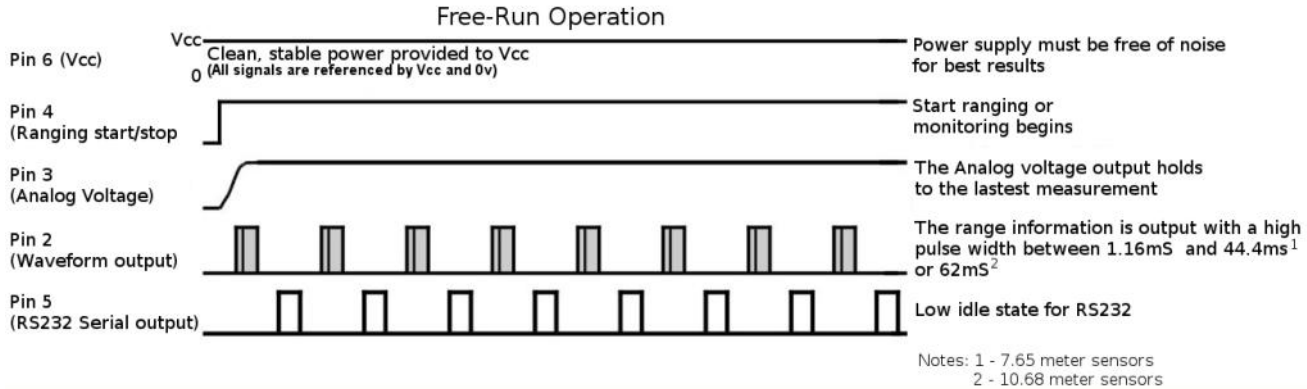

Real-Time Operation

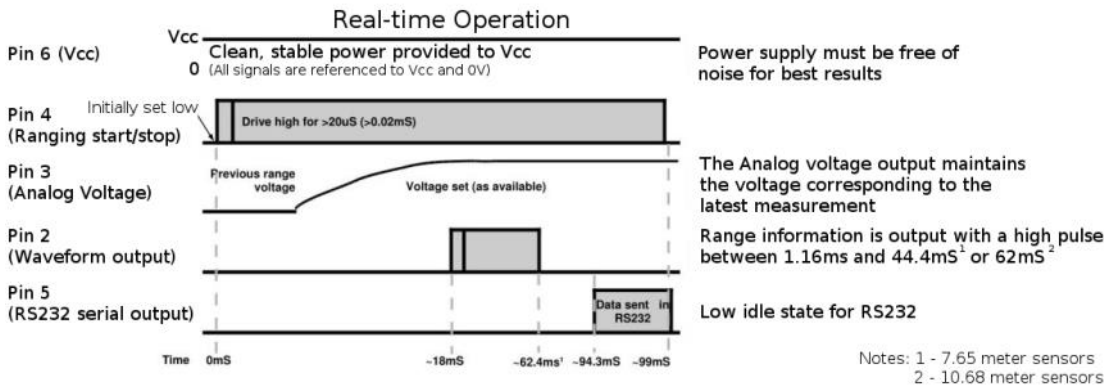

XL-MaxSonar-EZ/AE Timing Description

175mS after power-up, the XL-MaxSonar® is ready to begin ranging. If Pin-4 is left open or held high (20uS or greater), the sensor will take a range reading. The XL-MaxSonar® checks the Pin-4 at the end of every cycle. Range data can be acquired once every 99mS. Each 99mS period starts by Pin-4 being high or open, after which the XL-MaxSonar® calibrates and calculates for 20.5mS, and after which, twenty 42KHz waves are sent.

At this point, for the MB1260, the pulse width (PW) Pin-2 is set high and until an object is detected after which the pin is set low. If no target is detected the PW pin will be held high for up to 44.4mS¹ (i.e. 58uS * 765cm) or 62.0mS² (i.e. 58uS * 1068cm). (For the most accurate range data, use the PW output.)

For the MB1300 sensor series, The analog envelope output, Pin-2, will show the real-time signal return information of the analog waveform.

For both parts, the remainder of the 99mS time (less 4.7mS) is spent adjusting the analog voltage to the correct level, (and allowing the high acoustic power to dissipate). During the last 4.7mS, the serial data is sent.

Using Multiple Sensors in a single system

When using multiple ultrasonic sensors in a single system, there can be interference (cross-talk) from the other sensors. MaxBotix Inc., has engineered a solution to this problem for the XL-MaxSonar-EZ sensors. The solution is referred to as chaining. We have 3 methods of chaining that work well to avoid the issue of cross-talk.

The first method is AN Output Commanded Loop. The first sensor will range, then trigger the next sensor to range and so on for all the sensor in the array. Once the last sensor has ranged, the array stops until the first sensor is triggered to range again. Below is a diagram on how to set this up.

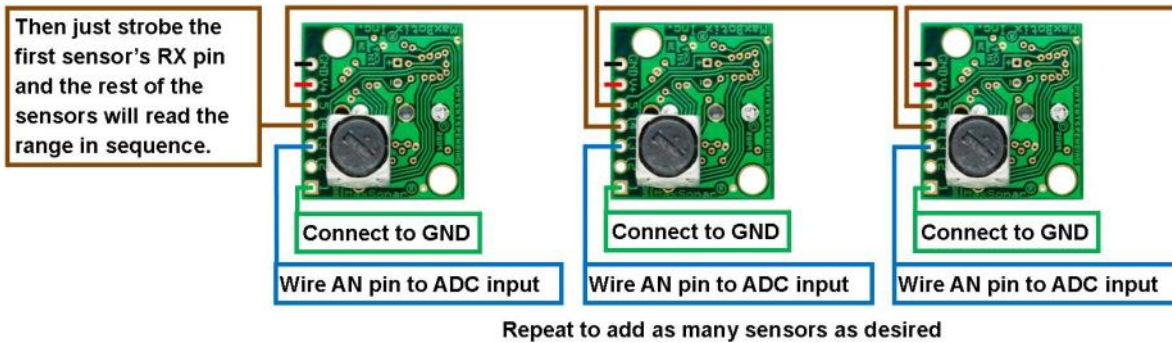

The next method is AN Output Constantly Looping. The first sensor will range, then trigger the next sensor to range and so on for all the sensor in the array. Once the last sensor has ranged, it will trigger the first sensor in the array to range again and will continue this loop indefinitely. Below is a diagram on how to set this up.

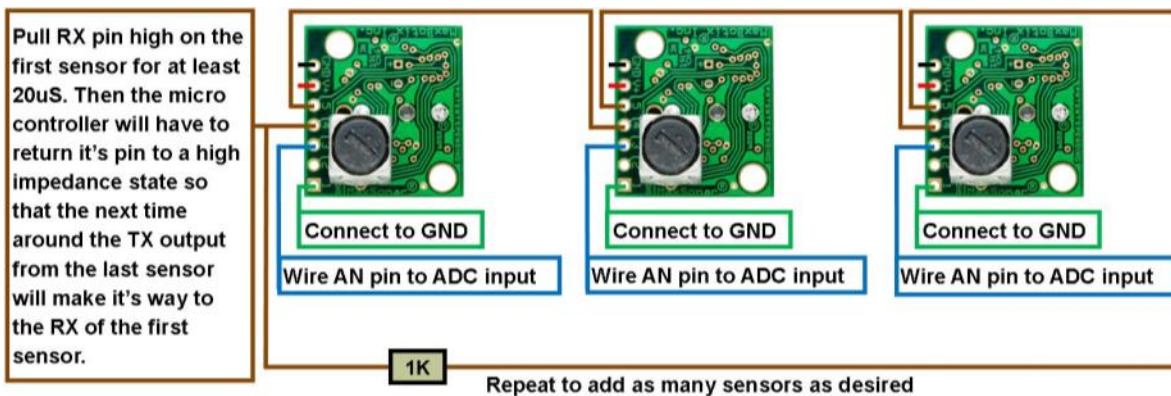

The final method is AN Output Simultaneous Operation. This method does not work in all applications and is sensitive to how the other sensors in the array are positioned in comparison to each other. Testing is recommend to verify this method will work for your application. All the sensors RX pins are conned together and triggered at the same time causing all the sensor to take a range reading at the same time. Once the range reading is complete, the sensors stop ranging until triggered next time. Below is a diagram on how to set this up.

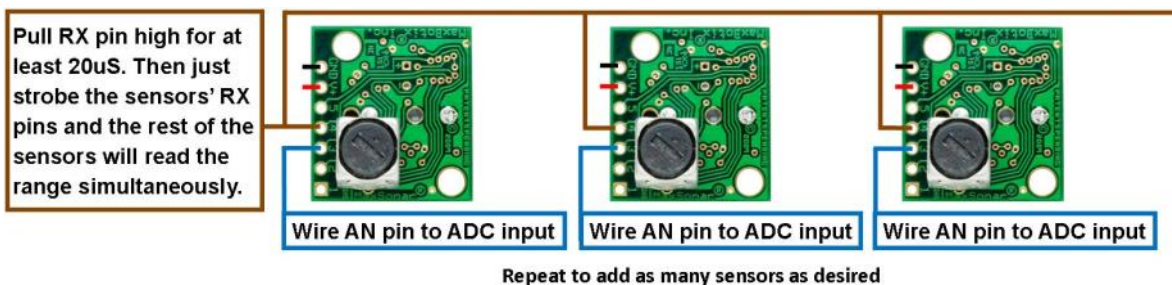

Independent Sensor Operation

The XL-MaxSonar-EZ sensors have the capability to operating independently when the user desires. When using the XL-MaxSonar-EZ sensors in single or independent sensor operation, it is easiest to allow the sensor to free-run. Free-run is the default mode of operation for all of the MaxBotix Inc., sensors. The XL-MaxSonar-EZ sensors have three separate outputs that update the range data simultaneously: Analog Voltage, Pulse Width, and RS232 Serial. Below are diagrams on how to connect the sensor for each of the three outputs when operating in a single or independent sensor operating environment.

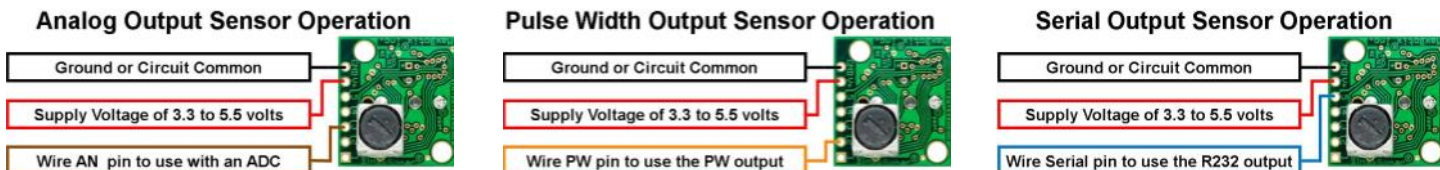

Selecting a XL-MaxSonar-EZ/AE

Different applications require different sensors. The XL-MaxSonar-EZ/AE product line offers varied sensitivity to allow you to select the best sensor to meet your needs.

The XL-MaxSonar-EZ Sensors At a Glance

People Detection Wide Beam High Sensitivity	Best Balance	Large Targets Narrow Beam Noise Tolerance
MB1200/MB1300 MB1260/MB1261	MB1210/MB1310 MB1220/MB1320	MB1230/MB1330 MB1240/MB1340

The diagram above shows how each product balances sensitivity and noise tolerance. This does not effect the maximum range, pin outputs, or other operations of the sensor. To view how each sensor will function to different sized targets reference the XL-MaxSonar-EZ Beam Patterns.

XL-MaxSonar®-EZ™ Beam Characteristics

Background Information Regarding our Beam Patterns

Each LV-MaxSonar-EZ sensor has a calibrated beam pattern. Each sensor is matched to provide the approximate detection pattern shown in this datasheet. This allows end users to select the part number that matches their given sensing application. Each part number has a consistent field of detection so additional units of the same part number will have similar beam patterns. The beam plots are provided to help identify an estimated detection zone for an application based on the acoustic properties of a target versus the plotted beam patterns.

Each beam pattern is a 2D representation of the detection area of the sensor. The beam pattern is actually shaped like a 3D cone (having the same detection pattern both vertically and horizontally). Detection patterns for dowels are used to show the beam pattern of each sensor. Dowels are long cylindered targets of a given diameter. The dowels provide consistent target detection characteristics for a given size target which allows easy comparison of one MaxSonar sensor to another MaxSonar sensor.

For each part number, the four patterns (A, B, C, and D) represent the detection zone for a given target size. Each beam pattern shown is determined by the sensor’s part number and target size. The actual beam angle changes over the full range. Use the beam pattern for a specific target at any given distance to calculate the beam angle for that target at the specific distance. Generally, smaller targets are detected over a narrower beam angle and a shorter distance. Larger targets are detected over a wider beam angle and a longer range.

People Sensing:
For users that desire to detect people, the detection area to the 1-inch diameter dowel, in general, represents the area that the sensor will reliably detect people.

MB1200/MB1300: XL-MaxSonar-EZ/AE0

The XL-MaxSonar-EZ/AE0 is the highest sensitivity and widest beam sensor of the XL-MaxSonar-EZ/AE sensor series. The wide beam makes this sensor ideal for a variety of applications including people detection, autonomous navigation, and wide beam applications.

Note: All sensors sold after Oct 01, 2013 have a minimum reported distance of 25cm. All sensors sold before this date have a 20cm minimum reported distance.

MB1200-MB1300

XL-MaxSonar®-EZ/AE0™ Beam Pattern

Sample results for measured beam pattern are shown on a 30-cm grid. The detection pattern is shown for dowels of varying diameters that are placed in front of the sensor

- A 6.1-mm (0.25-inch) diameter dowel
- B 2.54-cm (1-inch) diameter dowel
- C 8.89-cm (3.5-inch) diameter dowel

D 11-inch wide board moved left to right with the board parallel to the front sensor face.

This shows the sensor's range capability.

Note: For people detection the pattern typically falls between charts A and B.

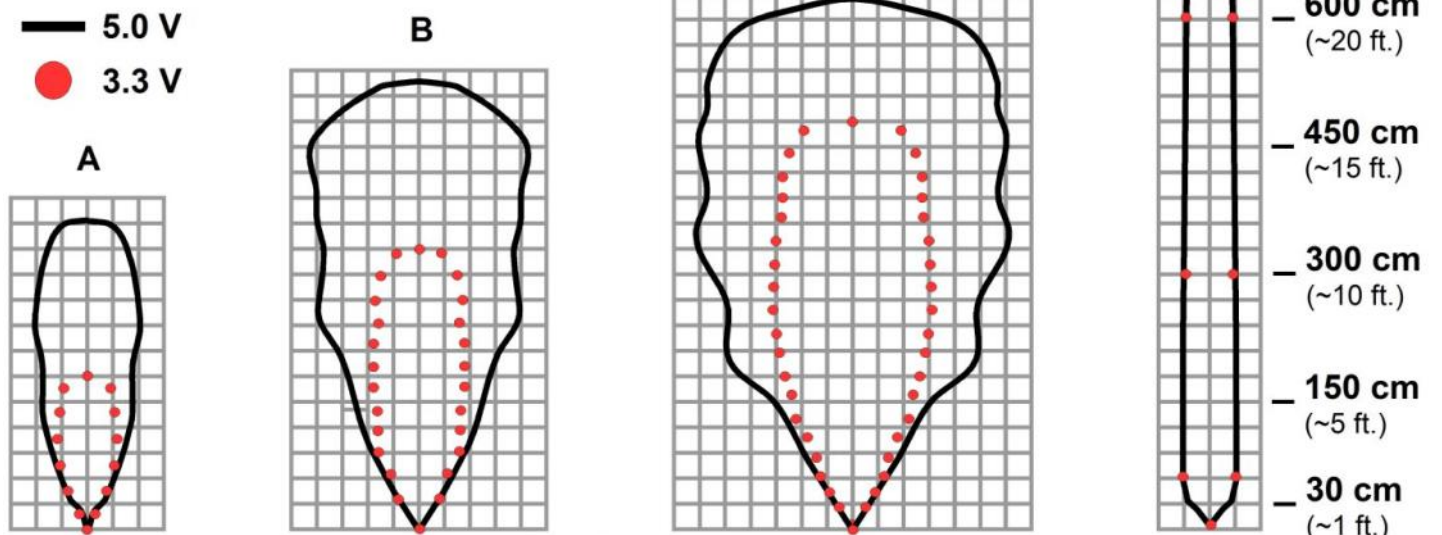

Beam Characteristics are Approximate

Beam Pattern drawn to a 1:95 scale for easy comparison to our other products.

MB1200/MB1300 Features and Benefits

- Widest and most sensitive beam pattern in XL-MaxSonar-EZ/AE line
- Low power consumption
- Easy to use interface
- Will pick up the most noise clutter of any of the sensors in XL-MaxSonar-EZ/AE line
- Detects smaller objects

- Best sensor to detect soft object in XL-MaxSonar-EZ line
- Requires use of less sensors to do same job
- Can detect people up to approximately 18 feet
- 3.3v to 5.5v operational voltage

MB1200/MB1300 Applications and Uses

- Great for people detection
- Security
- Motion detection
- Used with battery power
- Autonomous navigation
- Educational and hobby robotics
- Collision avoidance

MB1210/MB1310: XL-MaxSonar-EZ/AE1

The XL-MaxSonar-EZ/AE1 has slightly less sensitivity and narrower beam than the MB1200/MB1300 sensors. This makes the MB1210/MB1310 an ideal sensor for applications in which the MB1200/MB1300 are too sensitive.

Note: All sensors sold after Oct 01, 2013 have a minimum reported distance of 25cm. All sensors sold before this date have a 20cm minimum reported distance.

MB1210-MB1310

XL-MaxSonar®-EZ/AE1™ Beam Pattern

Sample results for measured beam pattern are shown on a 30-cm grid. The detection pattern is shown for dowels of varying diameters that are placed in front of the sensor

- A 6.1-mm (0.25-inch) diameter dowel
- B 2.54-cm (1-inch) diameter dowel
- C 8.89-cm (3.5-inch) diameter dowel

D 11-inch wide board moved left to right with the board parallel to the front sensor face. This shows the sensor's range capability.

Note: For people detection the pattern typically falls between charts A and B.

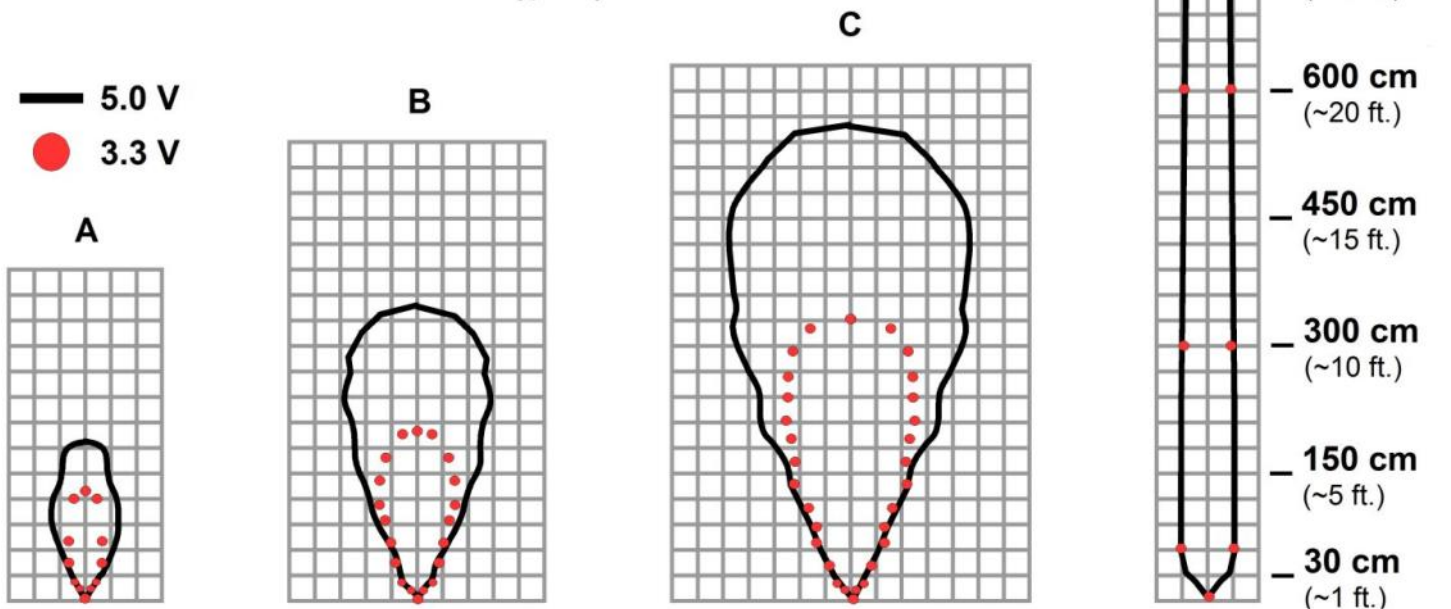

Beam Characteristics are Approximate

Beam Pattern drawn to a 1:95 scale for easy comparison to our other products.

MB1210/MB1310 Features and Benefits

- Great for applications in which the MB1200/MB1300 are too sensitive
- Low power consumption
- Easy to use interface
- Detects small objects
- Can detect people up to approximately 11 feet
- 3.3v to 5.5v operational voltage

MB1210/MB1310 Applications and Uses

- Great for people detection
- Security
- Motion detection
- Used with battery power
- Autonomous navigation
- Educational and hobby robotics
- Collision avoidance

MB1220/MB1320: XL-MaxSonar-EZ/AE2

The XL-MaxSonar-EZ/AE2 is the recommended sensor for users unsure of which XL-MaxSonar-EZ/AE sensor to use. This sensor balances sensitivity and detection to targets of different sizes. This sensor is a good compromise between sensitivity and side object rejection.

MB1220-MB1320

XL-MaxSonar[®]-EZ/AE2[™] Beam Pattern

Sample results for measured beam pattern are shown on a 30-cm grid. The detection pattern is shown for dowels of varying diameters that are placed in front of the sensor

- A** 6.1-mm (0.25-inch) diameter dowel
- B** 2.54-cm (1-inch) diameter dowel
- C** 8.89-cm (3.5-inch) diameter dowel

D 11-inch wide board moved left to right with the board parallel to the front sensor face. This shows the sensor's range capability.

Note: For people detection the pattern typically falls between charts A and B.

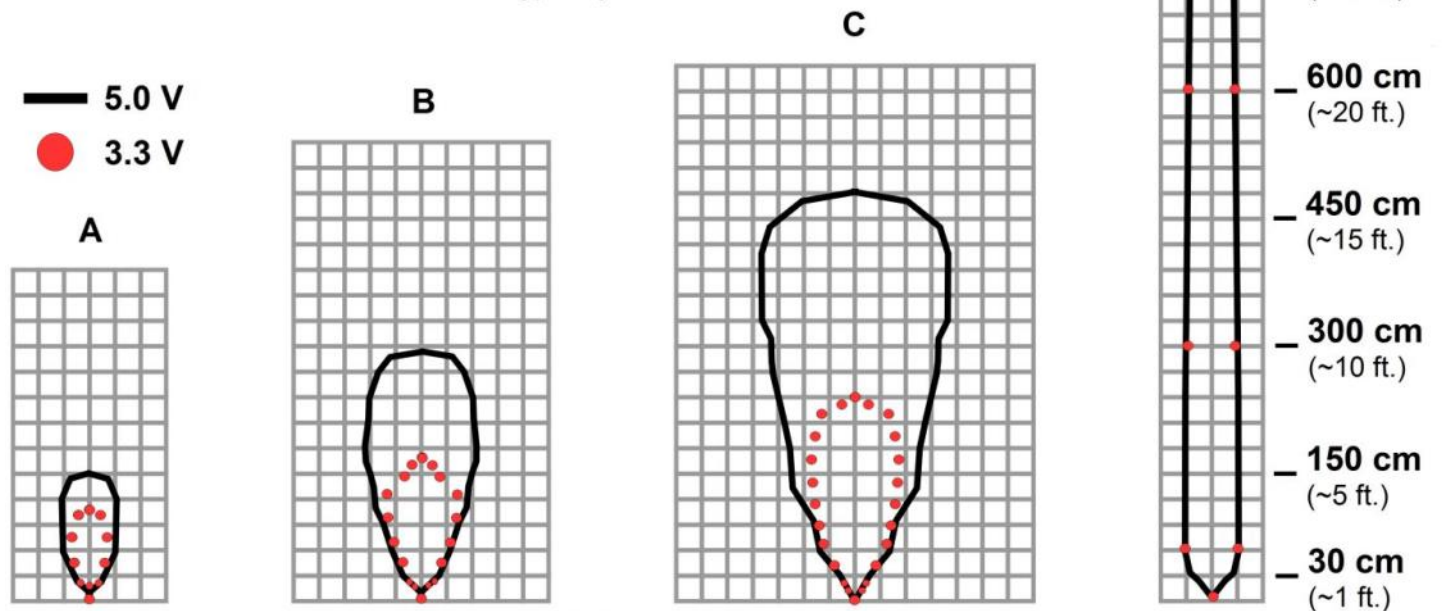

Beam Characteristics are Approximate

Beam Pattern drawn to a 1:95 scale for easy comparison to our other products.

MB1220/MB1320 Features and Benefits

- Recommended for users unsure of which sensor to use in their application
- Low power consumption
- Easy to use interface
- Good balance of sensitivity and side object rejection
- Can detect people up to approximately 10 feet

- 3.3v to 5.5v operational voltage

MB1220/MB1320 Applications and Uses

- Great for people detection
- Security
- Motion detection
- Landing flying objects
- Used with battery power
- Autonomous navigation
- Educational and hobby robotics
- Collision avoidance

MB1230/MB1330: XL-MaxSonar-EZ/AE3

The XL-MaxSonar-EZ/AE3 is a narrow beam, and is slightly more sensitive than the MB1240/MB1340. This makes the MB1230/MB1330 sensor a good choice in applications where the MB1240/MB1340 do not have enough sensitivity

MB1230-MB1330

XL-MaxSonar®-EZ/AE3™ Beam Pattern

Sample results for measured beam pattern are shown on a 30-cm grid. The detection pattern is shown for dowels of varying diameters that are placed in front of the sensor

A 6.1-mm (0.25-inch) diameter dowel

B 2.54-cm (1-inch) diameter dowel

C 8.89-cm (3.5-inch) diameter dowel

D 11-inch wide board moved left to right with the board parallel to the front sensor face.

This shows the sensor's range capability.

Note: For people detection the pattern typically falls between charts A and B.

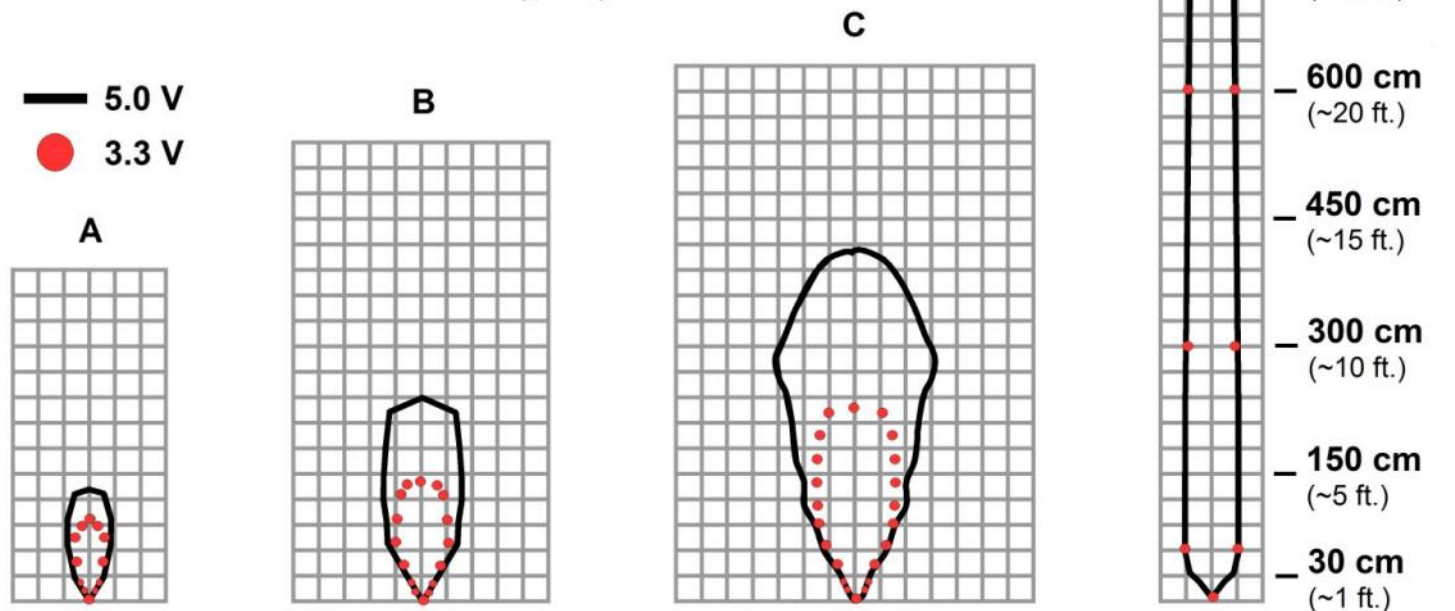

Beam Characteristics are Approximate

Beam Pattern drawn to a 1:95 scale for easy comparison to our other products.

MB1230/MB1330 Features and Benefits

- Slightly more sensitive than the MB1240/MB1340
- Low power consumption
- Easy to use interface
- Large Object detection
- Requires use of less sensors to do same job
- Can detect people up to approximately 8 feet

- 3.3v to 5.5v operational voltage

MB1230/MB1330 Applications and Uses

- Great for people detection
- Security
- Motion detection
- Landing flying objects
- Used with battery power
- Autonomous navigation
- Educational and hobby robotics
- Collision avoidance

MB1240/MB1340: XL-MaxSonar-EZ/AE4

The XL-MaxSonar-EZ/AE4 is the least sensitive and narrowest beam pattern in the XL-MaxSonar-EZ/AE sensor series. This makes the sensor great for applications in which there is a large amount of acoustic. The MB1240/MB1340 sensor is also recommended in applications where only large target detection is required.

MB1240-MB1340

XL-MaxSonar®-EZ/AE4™ Beam Pattern

Sample results for measured beam pattern are shown on a 30-cm grid. The detection pattern is shown for dowels of varying diameters that are placed in front of the sensor

A 6.1-mm (0.25-inch) diameter dowel

B 2.54-cm (1-inch) diameter dowel

C 8.89-cm (3.5-inch) diameter dowel

D 11-inch wide board moved left to right with the board parallel to the front sensor face.

This shows the sensor's range capability.

Note: For people detection the pattern typically falls between charts A and B.

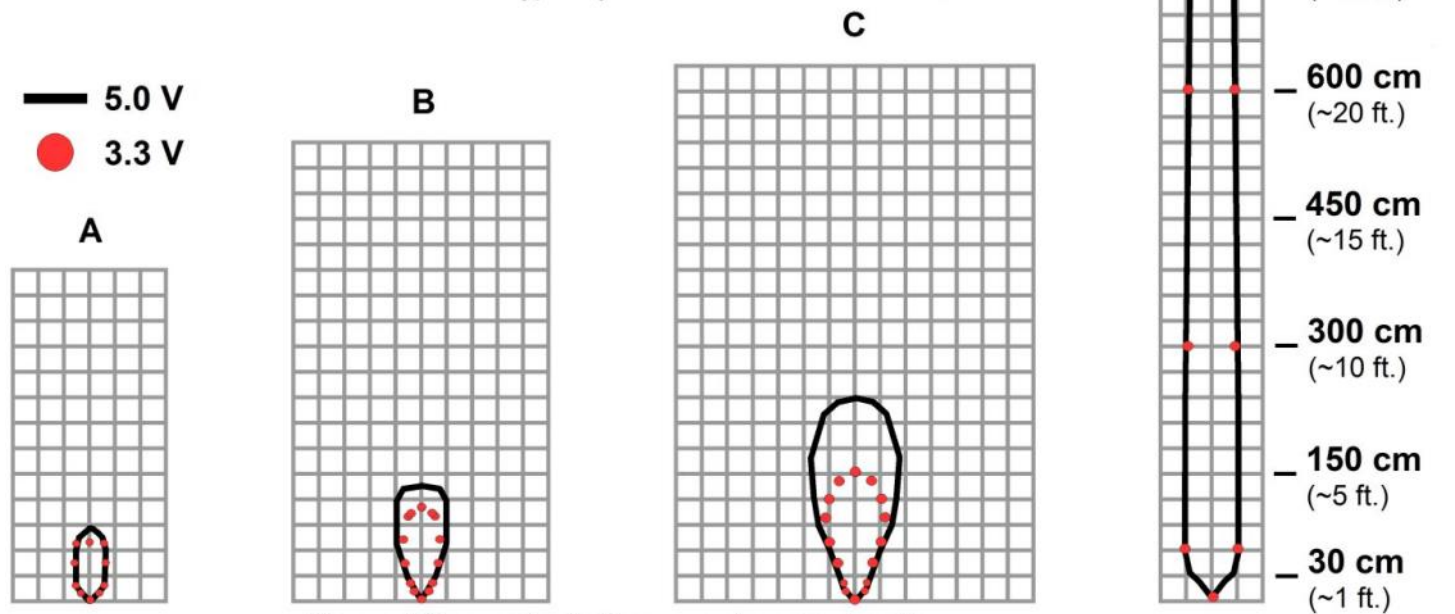

Beam Characteristics are Approximate

Beam Pattern drawn to a 1:95 scale for easy comparison to our other products.

MB1240/MB1340 Features and Benefits

- Narrowest beam in the XL-MaxSonar-EZ/AE sensor line
- Low power consumption
- Easy to use interface
- Large target detection
- Acoustic noise rejection
- 3.3v to 5.5v operational voltage

MB1240/MB1340 Applications and Uses

- Great for people detection
- Security
- Motion detection
- Recommended for multi-copters and UAV's
- Used with battery power
- Autonomous navigation
- Educational and hobby robotics
- Collision avoidance

MB1260/MB1360: XL-MaxSonar-EZ/AEL0

The XL-MaxSonar-EZ/AEL0 has the same gain and sensitive as the MB1200/MB1300. This sensor features a longer range of 1068cm to large targets. This sensor is recommended for long range measurement to large targets.

Note: Firmware rev 1.6b and newer have a 25cm minimum reported distance. This applies to all sensors sold after February 20, 2013. All sensors sold before this date have a 20cm minimum reported distance.

MB1260-MB1360

XL-MaxSonar®-EZ/AEL0™ Beam Pattern

Sample results for measured beam pattern are shown on a 30-cm grid. The detection pattern is shown for dowels of varying diameters that are placed in front of the sensor

- A 6.1-mm (0.25-inch) diameter dowel
- B 2.54-cm (1-inch) diameter dowel
- C 8.89-cm (3.5-inch) diameter dowel

D 11-inch wide board moved left to right with the board parallel to the front sensor face. This shows the sensor's range capability.

Note: For people detection the pattern typically falls between charts A and B.

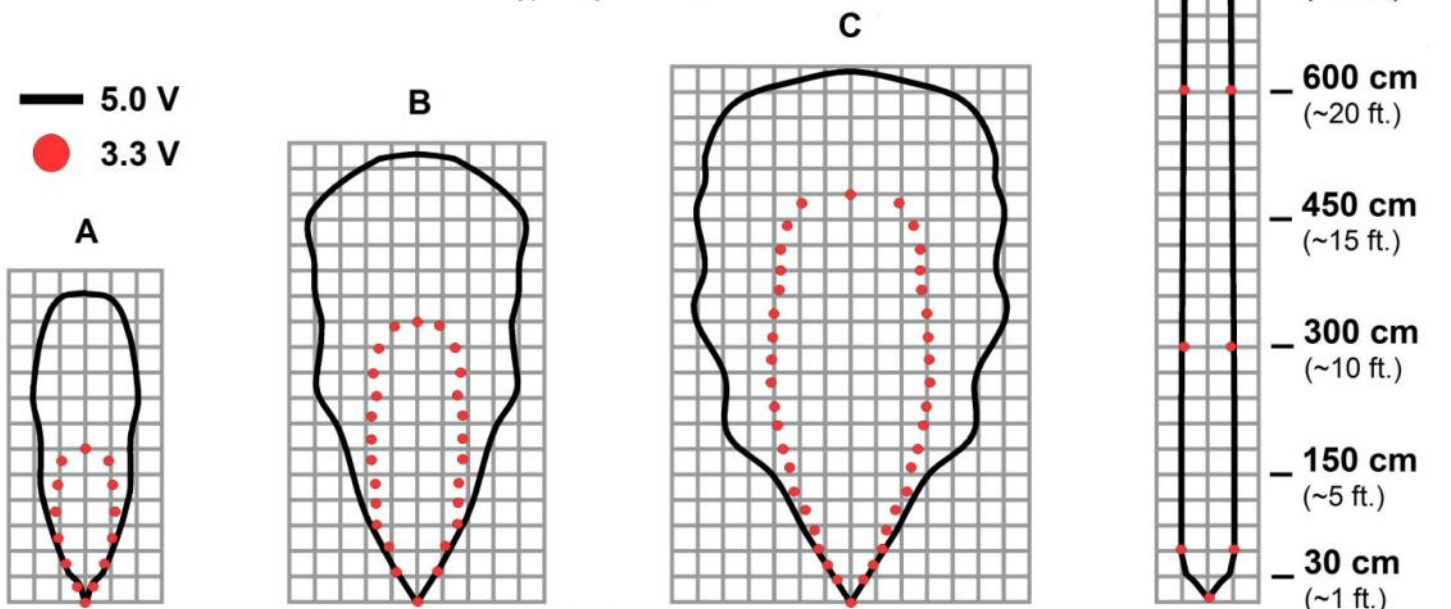

Beam Characteristics are Approximate

Beam Pattern drawn to a 1:95 scale for easy comparison to our other products.

MB1260/MB1360 Features and Benefits

- Shares same beam pattern with MB1200/MB1300
- Maximum range of 1068cm to large targets
- Low power consumption
- Easy to use interface
- Can detect people to approximately 18feet
- 3.3v to 5v operational voltage

MB1260/MB1360 Applications and Uses

- Great for people detection
- Security
- Motion detection
- Used with battery power
- Autonomous navigation
- Educational and hobby robotics
- Collision avoidance
- Long range detection

MB1261/MB1361: XL-MaxSonar-EZL/AEL1

The XL-MaxSonar-EZL/AEL1 is the long range version of the MB1210/MB1310 ultrasonic sensor. This sensor features a longer maximum range of 1068cm to large targets. This sensor is recommended for applications in which the MB1210/MB1310 do not have a long enough detection distance.

MB1261-MB1361

XL-MaxSonar®-EZ/AEL1™ Beam Pattern

Sample results for measured beam pattern are shown on a 30-cm grid. The detection pattern is shown for dowels of varying diameters that are placed in front of the sensor

- A** 6.1-mm (0.25-inch) diameter dowel
- B** 2.54-cm (1-inch) diameter dowel
- C** 8.89-cm (3.5-inch) diameter dowel

D 11-inch wide board moved left to right with the board parallel to the front sensor face. This shows the sensor's range capability.

Note: For people detection the pattern typically falls between charts A and B.

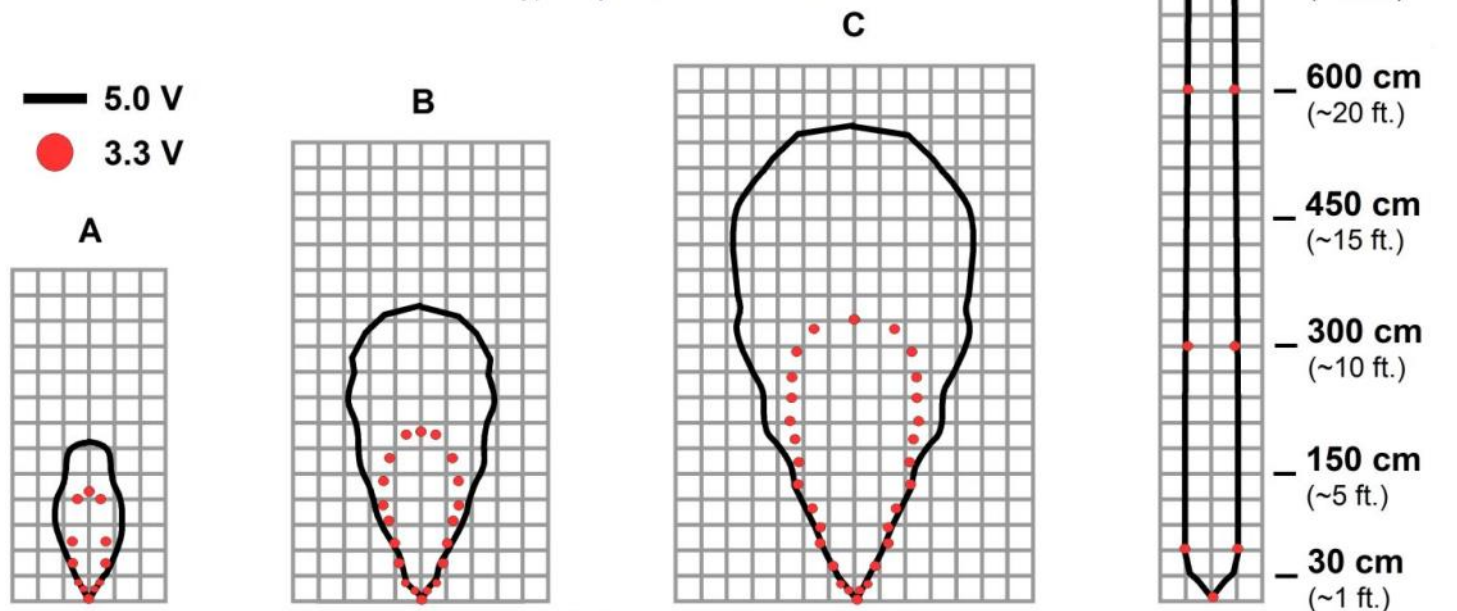

Beam Characteristics are Approximate

Beam Pattern drawn to a 1:95 scale for easy comparison to our other products.

MB1261/MB1361 Features and Benefits

- Same beam pattern as the MB1210/MB1310
- Long range of 1068cm to large targets
- Low power consumption
- Easy to use interface
- Detects smaller objects
- Requires use of less sensors to do same job

- Can detect people up to approximately 11 feet
- 3.3v to 5v operational voltage

MB1261/MB1361 Applications and Uses

- Great for people detection
- Security
- Motion detection
- Used with battery power
- Autonomous navigation
- Educational and hobby robotics
- Collision avoidance
- Long range detection

Have the right sensor for your application?

Select from this product list for Protected and Non-Protected Environments.

Protected Environments



1 mm Resolution
HRLV-MaxSonar-EZ

1 in Resolution
LV-MaxSonar-EZ
LV-ProxSonar-EZ

1 cm Resolution
XL-MaxSonar-EZ
XL-MaxSonar-AE
XL-MaxSonar-EZL
XL-MaxSonar-AEL

1 mm Resolution
HRUSB-MaxSonar-EZ
1 in Resolution
USB-ProxSonar-EZ

Non-Protected Environments

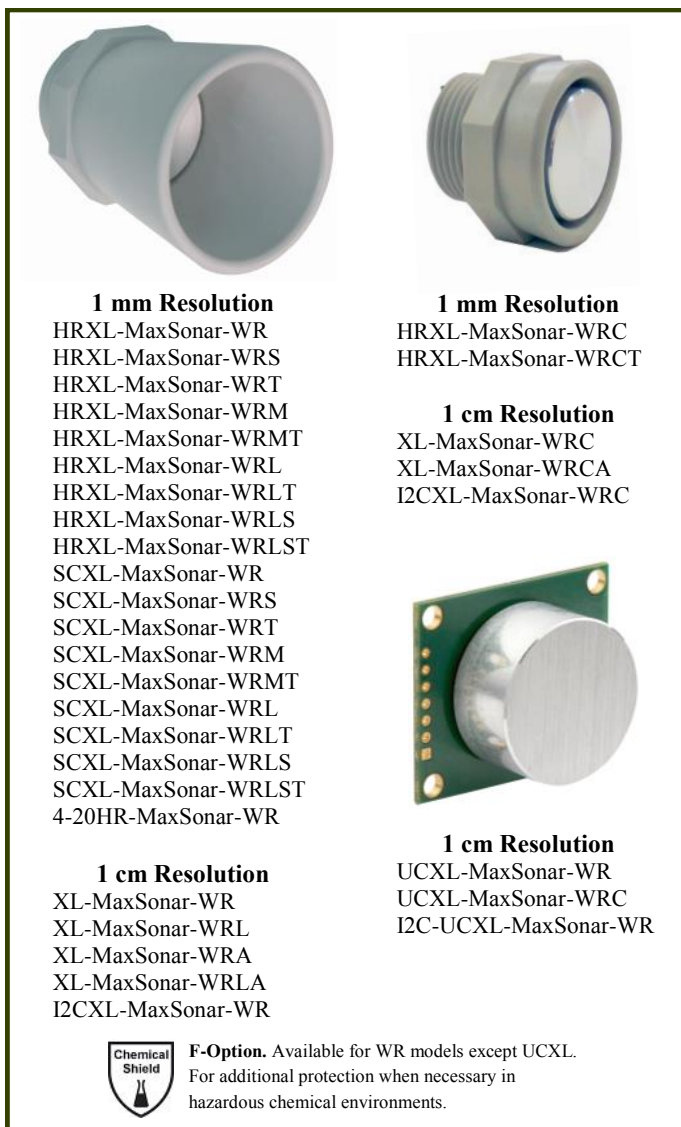

1 mm Resolution
HRXL-MaxSonar-WR
HRXL-MaxSonar-WRS
HRXL-MaxSonar-WRT
HRXL-MaxSonar-WRM
HRXL-MaxSonar-WRMT
HRXL-MaxSonar-WRL
HRXL-MaxSonar-WRLT
HRXL-MaxSonar-WRLS
HRXL-MaxSonar-WRLST
SCXL-MaxSonar-WR
SCXL-MaxSonar-WRS
SCXL-MaxSonar-WRT
SCXL-MaxSonar-WRM
SCXL-MaxSonar-WRMT
SCXL-MaxSonar-WRL
SCXL-MaxSonar-WRLT
SCXL-MaxSonar-WRLS
SCXL-MaxSonar-WRLST
4-20HR-MaxSonar-WR

1 mm Resolution
HRXL-MaxSonar-WRC
HRXL-MaxSonar-WRCT

1 cm Resolution
XL-MaxSonar-WRC
XL-MaxSonar-WRCA
I2CXL-MaxSonar-WRC

1 cm Resolution
UCXL-MaxSonar-WR
UCXL-MaxSonar-WRC
I2C-UCXL-MaxSonar-WR

1 cm Resolution
XL-MaxSonar-WR
XL-MaxSonar-WRL
XL-MaxSonar-WRA
XL-MaxSonar-WRLA
I2CXL-MaxSonar-WR



F-Option. Available for WR models except UCXL.
For additional protection when necessary in hazardous chemical environments.

Accessories — More information is online.

MB7954 — Shielded Cable

The MaxSonar Connection Wire is used to reduce interference caused by electrical noise on the lines. This cable is a great solution to use when running the sensors at a long distance or in an area with a lot of EMI and electrical noise.



MB7950 — XL-MaxSonar-WR Mounting Hardware

The MB7950 Mounting Hardware is selected for use with our outdoor ultrasonic sensors. The mounting hardware includes a steel lock nut and two O-ring (Buna-N and Neoprene) each optimal for different applications.



MB7955 / MB7956 / MB7957 / MB7958 / MB7972 — HR-MaxTemp

The HR-MaxTemp is an optional accessory for the HR-MaxSonar. The HR-MaxTemp connects to the HR-MaxSonar for automatic temperature compensation without self heating.



MB7961 — Power Supply Filter

The power supply filter is recommended for applications with unclean power or electrical noise.



MB7962 / MB7963 / MB7964 / MB7965 — Micro-B USB Connection Cable

The MB7962, MB7963, MB7964 and MB7965 Micro-B USB cables are USB 2.0 compliant and backwards compatible with USB 1.0 standards. Varying lengths.



MB7973 — CE Lightning/Surge Protector

The MB7973 adds protection required to meet the Lightning/Surge IEC61000-4-5 specification.



Product / specifications subject to change without notice. The names MaxBotix®, MaxSonar®, EZ, E20, E21, E22, E23, E24, HR, AE0, AE1, AE2, AE3, AE4, WR1, and WRC1 are trademarks of MaxBotix Inc.