



## SURFACE MOUNT SCHOTTKY BARRIER RECTIFIER

### Features

- ◆ Trench MOS Schottky barrier diodes
- ◆ Low forward voltage drop
- ◆ low profile - typical body height 1.1 mm
- ◆ Moisture sensitivity: level 1, per J-STD-020
- ◆ High temperature soldering guaranteed:  
260 °C/10 seconds - RoHS Compliant
- ◆ Halogen-free according to IEC 61249-2-21 definition

TO-277

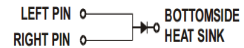
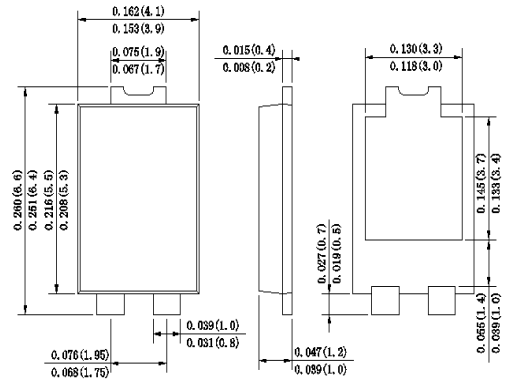

Dimensions in inches and (millimeters)

### Mechanical Data

**Case :** JEDEC TO-277 Molded plastic body  
Case Material: Molding compound meets UL 94V-0 flammability rating

**Terminals :**Plated Leads Solderable per MIL-STD-202,Method 208

**Polarity :** Polarity symbol marking on body

**Mounting Position :** Any

**Weight :** 0.003 ounce, 0.092 grams

### Maximum Ratings And Electrical Characteristics

Ratings at 25°C ambient temperature unless otherwise specified.

Single phase half-wave 60Hz, resistive or inductive load, for capacitive load current derate by 20%.

Parameter	SYMBOL	ST2045		UNIT
		MDD	ST2045	
Marking Code				
Maximum repetitive peak reverse voltage	$V_{RRM}$	45		V
Maximum DC blocking voltage	$V_{DC}$			
RMS Reverse voltage	$V_{RMS}$	32		V
Average Rectified Output Current	$I_{(O)}$	20		A
Non-Repetitive Peak Forward Surge 8.3ms Single Half Sine-Wave Superimposed on rated load(JEDEC Method)	$I_{FSM}$	400		A

Electrical Characteristics  $T_a=25^\circ\text{C}$  unless otherwise noted

Parameter	Test Conditions	Symbol	Value		Unit
			Typ	Max	
Forward Voltage Drop at 20A	$T_A=25^\circ\text{C}$	$V_F$	0.47	0.50	V
	$T_A=125^\circ\text{C}$		0.42	0.45	
Peak reverse current at rated DC blocking voltage	$T_A=25^\circ\text{C}$	$I_R$	35	60	uA
	$T_A=125^\circ\text{C}$		40	70	
Operating junction storage temperature range		$T_J$	-55 to +150		°C
Storage temperature range		$T_{STG}$	-55 to +150		°C
Typical thermal resistance Junction to Ambient		$R_{\theta JC}$	1		°C/W

**Note:** 1. The typical data above is for reference only.

DN:T20305A0



## Ratings And Characteristic Curves

FIG.1: Forward Output Current Derating Curve

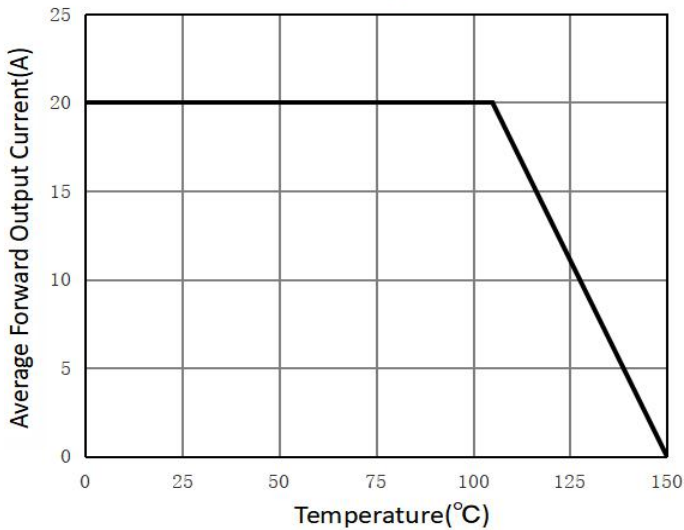

FIG.2: Maximum Non-Repetitive Peak Forward Surge Current

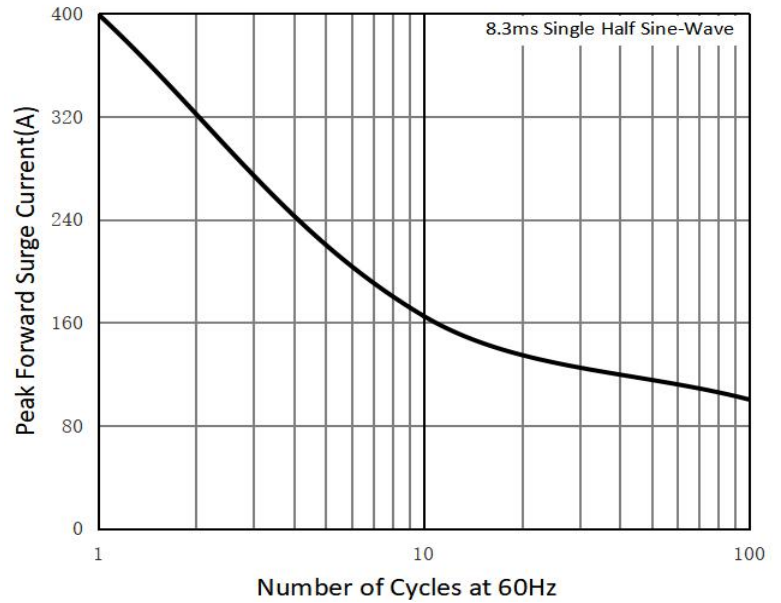

FIG.3: Typical Instantaneous Forward Characteristics

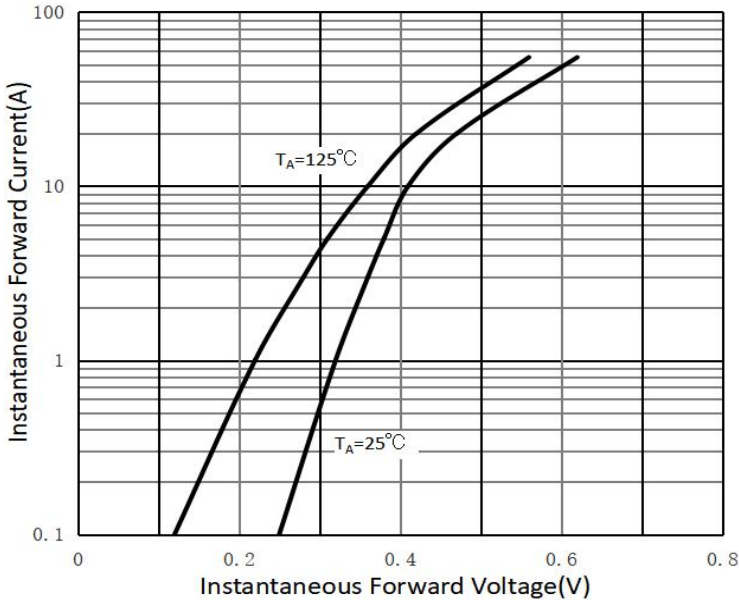
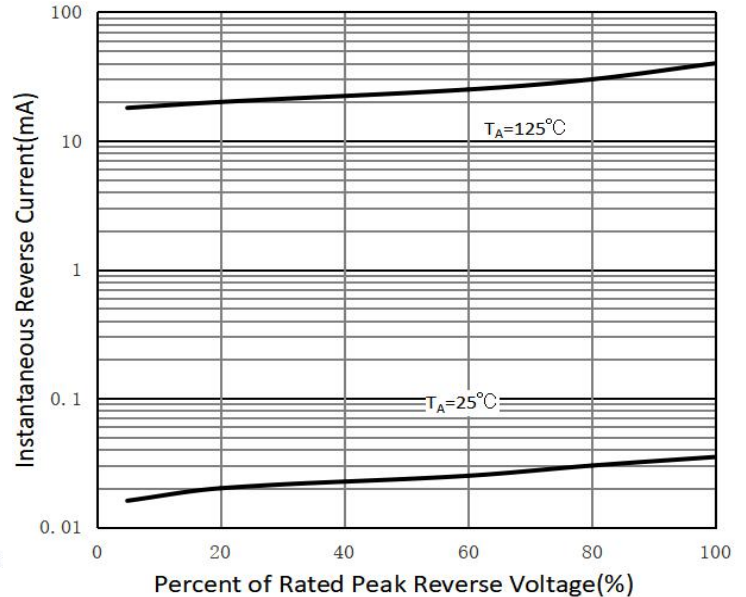
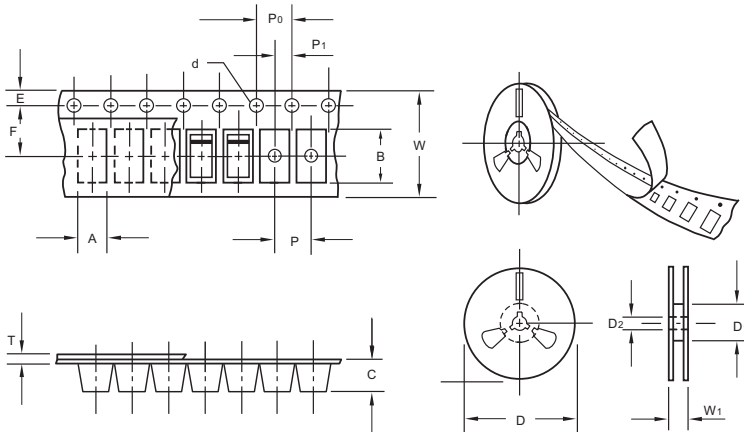

FIG.4: Typical Reverse Characteristics



The curve above is for reference only.

## Packing information



unit:mm

Item	Symbol	Tolerance	TO-277
Carrier width	A	0.1	4.45
Carrier length	B	0.1	7.0
Carrier depth	C	0.1	1.60
Sprocket hole	d	0.05	1.55
13" Reel outside diameter	D	2.0	330.00
13" Reel inner diameter	D <sub>1</sub>	min	50.0
Feed hole diameter	D <sub>2</sub>	0.5	13.00
Sprocket hole position	E	0.1	1.75
Punch hole position	F	0.1	7.50
Punch hole pitch	P	0.1	8.00
Sprocket hole pitch	P <sub>0</sub>	0.1	4.00
Embossment center	P <sub>1</sub>	0.1	2.00
Overall tape thickness	T	0.1	0.25
Tape width	W	0.3	12.00
Reel width	W <sub>1</sub>	1.0	12.30

Note: Devices are packed in accordance with EIA standard RS-481-A and specifications listed above.

## Reel packing

PACKAGE	REEL SIZE	REEL (pcs)	COMPONENT SPACING (m/m)	BOX (pcs)	INNER BOX (m/m)	REEL DIA, (m/m)	CARTON SIZE (m/m)	CARTON (pcs)	APPROX. GROSS WEIGHT (kg)
TO-277	13"	5,000	4.0	10,000	210*208*203	330	430*430*235	80,000	13.0

## Suggested Pad Layout

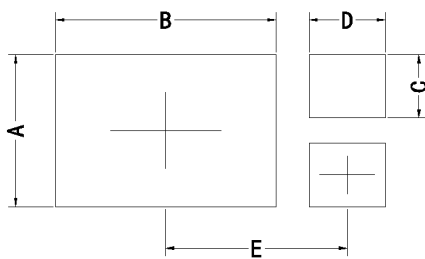

Symbol	Unit (mm)	Unit (inch)
A	3.60	0.142
B	5.35	0.211
C	1.50	0.059
D	1.85	0.073
E	4.30	0.169

## Important Notice and Disclaimer

Microdiode Electronics (Jiangsu) reserves the right to make changes to this document and its products and specifications at any time without notice. Customers should obtain and confirm the latest product information and specifications before final design, purchase or use.

Microdiode Electronics (Jiangsu) makes no warranty, representation or guarantee regarding the suitability of its products for any particular purpose, nor does Microdiode Electronics (Jiangsu) assume any liability for application assistance or customer product design. Microdiode Electronics (Jiangsu) does not warrant or accept any liability with products which are purchased or used for any unintended or unauthorized application.

No license is granted by implication or otherwise under any intellectual property rights of Microdiode Electronics (Jiangsu).

Microdiode Electronics (Jiangsu) products are not authorized for use as critical components in life support devices or systems without express written approval of Microdiode Electronics (Jiangsu).